

What's wrong with PHP?

4Developers - April 12th - Warsaw (Poland)

me, myself and I

- ▶ Ole Michaelis
- ▶ [@CodeStars](#)
- ▶ github.com/nesQuick
- ▶ codestars.eu



*working
@Jimdo*

*“Open Source
Rockstar”*





WE ARE HIRING
(still need more help in conquering the world!)

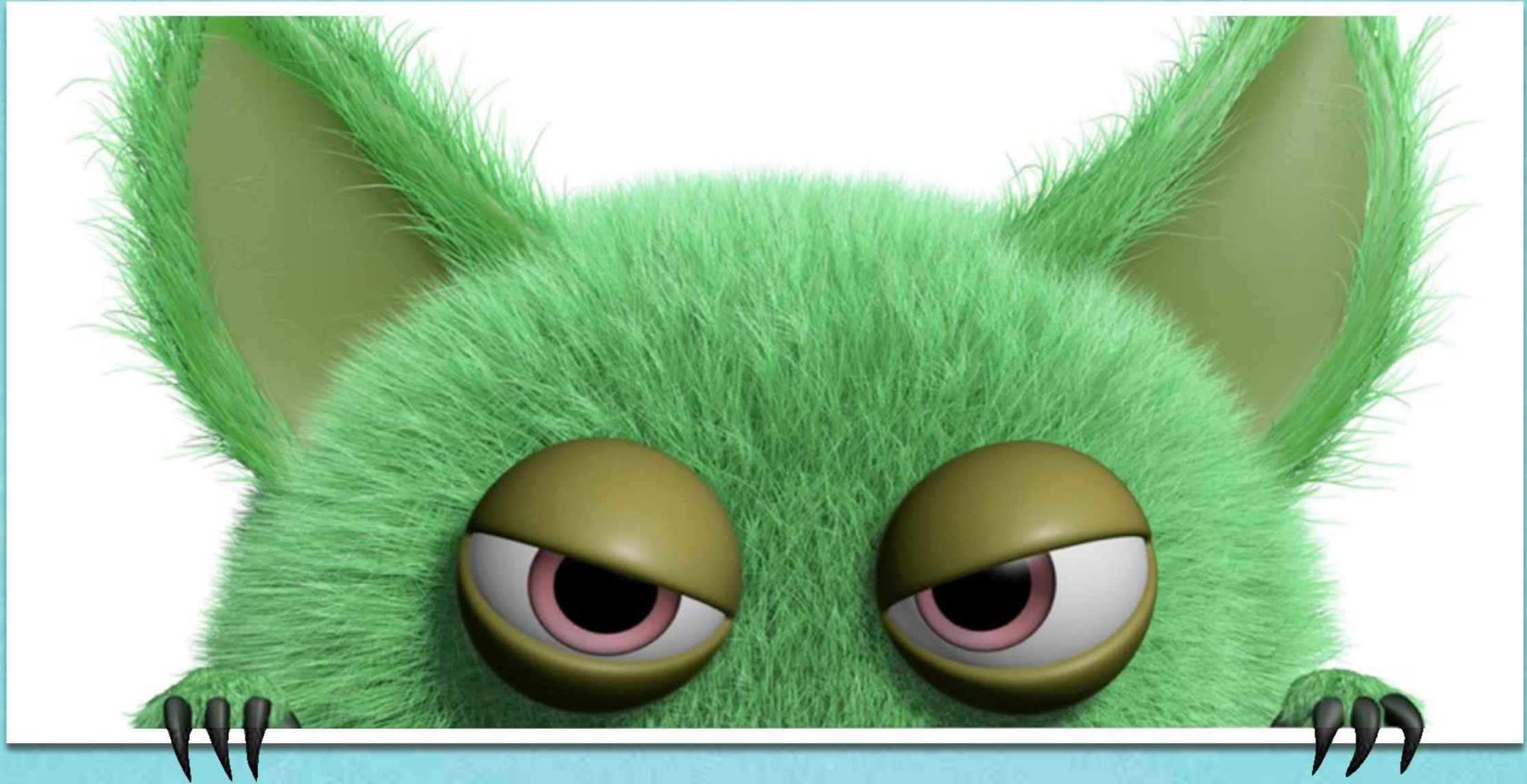

don't feed the trolls!

kind of a disclaimer

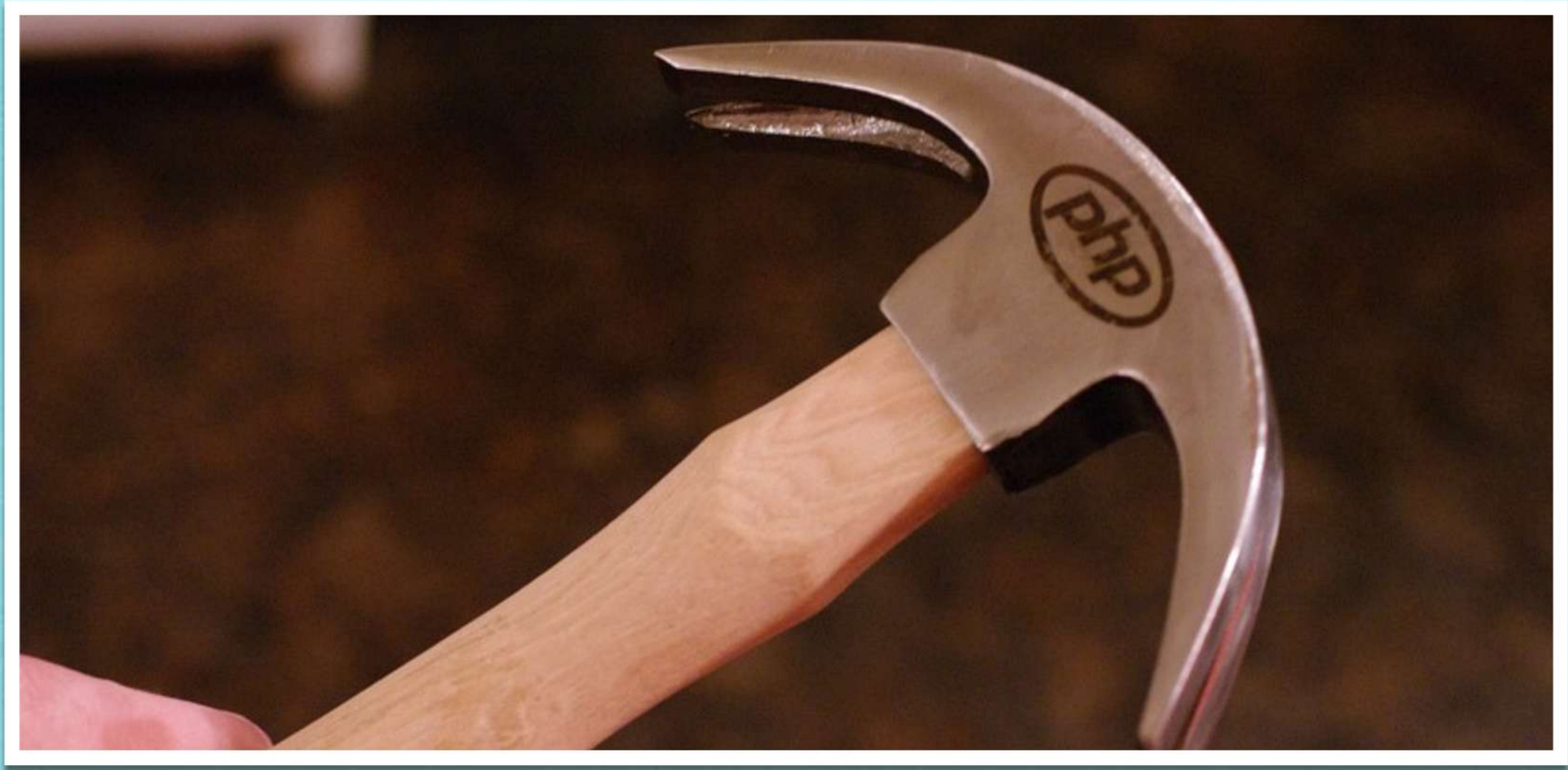

so, what's wrong with php?

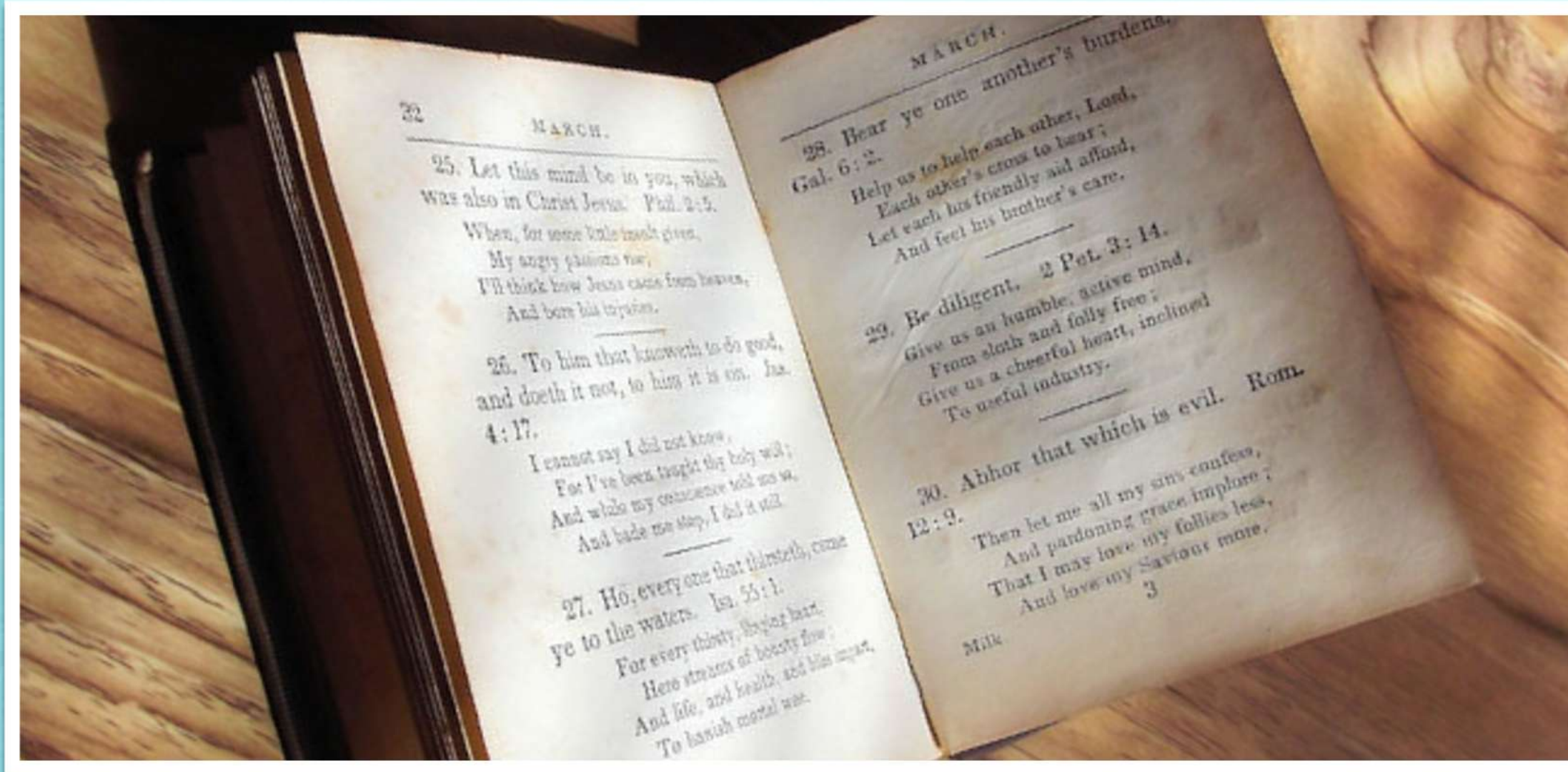

the story
of a language nobody likes!



PHP SUCKS!

**I can't
name
it!**

*but, finally there was
one thing ...*



open source



open source

**FUCK
YEAH!**

Top Languages

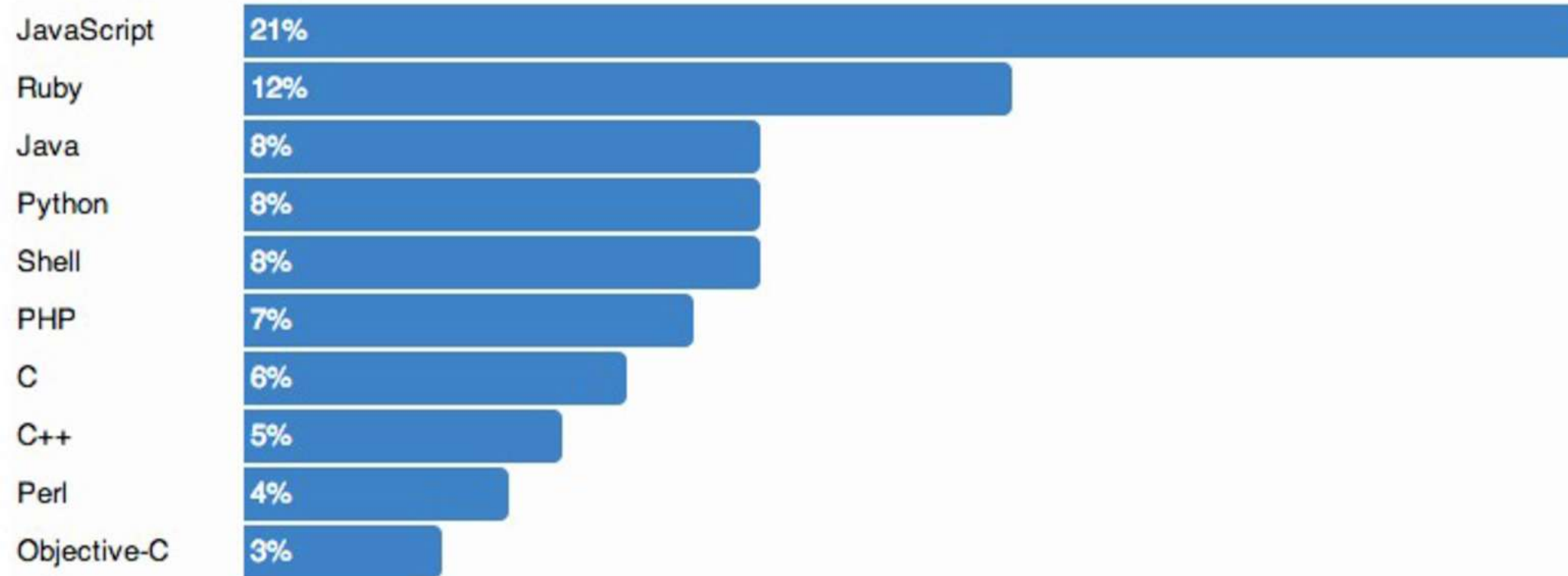

dafuq?

Top Languages

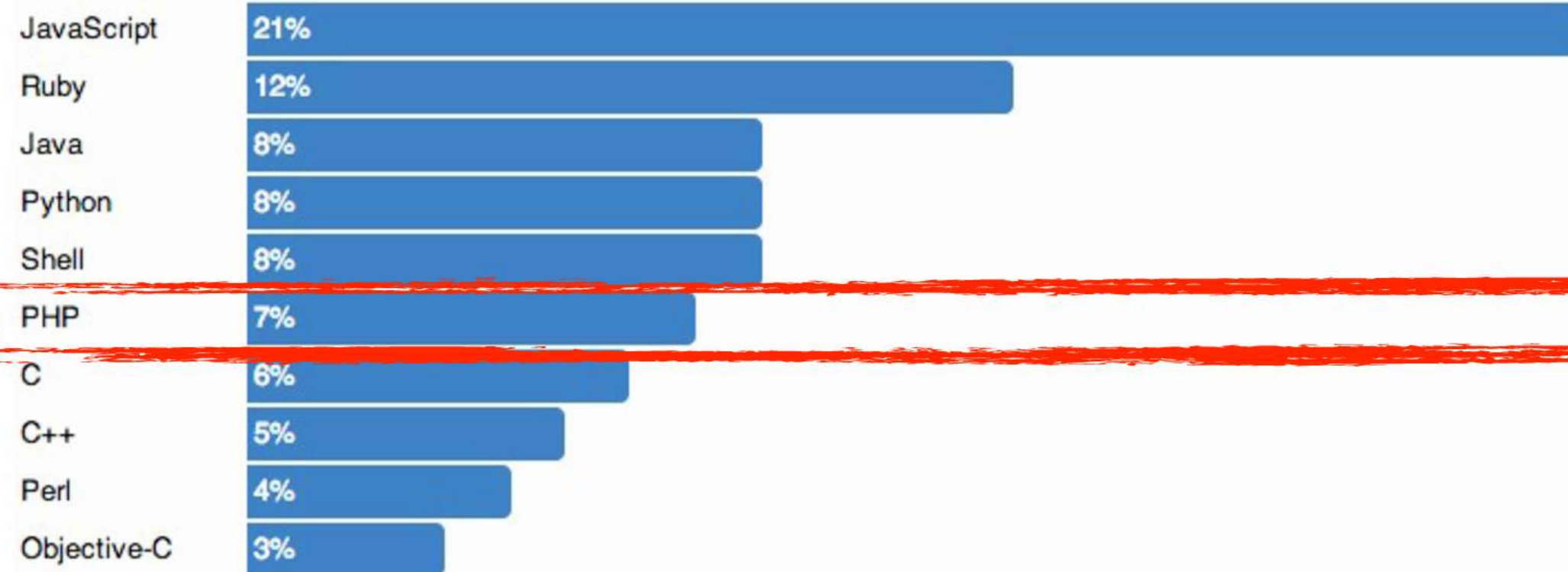

dafuq?

php is #6 on github

20.000.000*

sites running on PHP

*** 8.000.000 Jimdo pages :D**



flickrr



CHECK



so why is it?

php sample codes



Web Images Maps Shopping More ▾ Search tools

About 62,700,000 results (0.38 seconds)

[PHP Syntax - W3Schools](#)

www.w3schools.com/php/php_syntax.asp

A **PHP** file normally contains HTML tags, and some **PHP** scripting **code**. Below, we have an **example** of a simple **PHP** file, with a **PHP** script that sends the text ...

[HTML - PHP Form Example](#)

www.tizag.com/phpT/examples/formex.php

Our **example** will show you a method using a single **.php** file, combining both ... We will be integrating more **PHP code** into our form as we continue on so be ...

[List All Sample Codes. PHP-GTK2 Cookbook](#)

www.kksou.com/php-gtk2/sample-codes/

Results 1 - 30 of 513 – List All **Sample Codes**. Collection of problems, solutions, ...

Sample Code	Title	Hits
Sample Code 1:	How to get started	31783
Sample Code 2:	How to change the size of GtkWindow	19894

let's check

*awwwwww ... *rageface**

php sample codes



Web Images Maps Shopping More ▾ Search tools

About 62,700,000 results (0.38 seconds)

[PHP Syntax - W3Schools](#)

www.w3schools.com/php/php_syntax.asp

A **PHP** file normally contains HTML tags, and some **PHP** scripting **code**. Below, we have an **example** of a simple **PHP** file, with a **PHP** script that sends the text ...

[HTML - PHP Form Example](#)

www.tizag.com/phpT/examples/formex.php

Our **example** will show you a method using a single **.php** file, combining both ... We will be integrating more **PHP code** into our form as we continue on so be ...

[List All Sample Codes. PHP-GTK2 Cookbook](#)

www.kksou.com/php-gtk2/sample-codes/

Results 1 - 30 of 513 – List All **Sample Codes**. Collection of problems, solutions, ...

Sample Code	Title	Hits
Sample Code 1:	How to get started	31783
Sample Code 2:	How to change the size of GtkWindow	19894

let's check

*awwwwww ... *rageface**

php sample codes 

Web Ima

About 62,700

[PHP Syntax](#)
www.w3schools.com
A PHP file normally has an extension of .php

[HTML - PHP](#)
www.tizag.com
Our example will be integrated into the HTML page.

[List All Sample Codes](#)
www.kksou.com

Example

```
<!DOCTYPE html>
<html>
<body>

<h1>My first PHP page</h1>

<?php
echo "Hello World!";
?>

</body>
</html>
```

[Show example >](#)

Results 1 - 30 of 513 – List All **Sample Codes**. Collection of problems, solutions, ...

Sample Code	Title	Hits
Sample Code 1:	How to get started	31783
Sample Code 2:	How to change the size of GtkWidget	19894

let's check

*awwwwww ... *rageface**

php sample codes



Web Images Maps Shopping More ▾ Search tools

About 62,700,000 results (0.38 seconds)

[PHP Syntax - W3Schools](#)

www.w3schools.com/php/php_syntax.asp

A **PHP** file normally contains HTML tags, and some **PHP** scripting **code**. Below, we have an **example** of a simple **PHP** file, with a **PHP** script that sends the text ...

[HTML - PHP Form Example](#)

www.tizag.com/phpT/examples/formex.php

Our **example** will show you a method using a single **.php** file, combining both ... We will be integrating more **PHP code** into our form as we continue on so be ...

[List All Sample Codes. PHP-GTK2 Cookbook](#)

www.kksou.com/php-gtk2/sample-codes/

Results 1 - 30 of 513 – List All **Sample Codes**. Collection of problems, solutions, ...

Sample Code	Title	Hits
Sample Code 1:	How to get started	31783
Sample Code 2:	How to change the size of GtkWindow	19894

let's check

*awwwwww ... *rageface**

php sample codes



Web Images Maps Shopping More ▾ Search tools

About 62,700,000 results (0.38 seconds)

[PHP Syntax - W3Schools](#)

www.w3schools.com/php/php_syntax.asp

A **PHP** file normally contains HTML tags, and some **PHP** scripting **code**. Below, we have an **example** of a simple **PHP** file, with a **PHP** script that sends the text ...

[HTML - PHP Form Example](#)

www.tizag.com/phpT/examples/formex.php

Our **example** will show you a method using a single **.php** file, combining both ... We will be integrating more **PHP code** into our form as we continue on so be ...

[List All Sample Codes. PHP-GTK2 Cookbook](#)

www.kksou.com/php-gtk2/sample-codes/

Results 1 - 30 of 513 – List All **Sample Codes**. Collection of problems, solutions, ...

Sample Code	Title	Hits
Sample Code 1:	How to get started	31783
Sample Code 2:	How to change the size of GtkWindow	19894

let's check

*awwwwww ... *rageface**

php sample codes



Web Images Maps Shopping More ▾ Search tools

About 62,700,000 results (0.38 seconds)

[PHP Syntax - W3Schools](#)

www.w3schools.com/php/php_syntax.asp

A **PHP** file normally contains HTML tags, and some **PHP** scripting **code**. Below, we have an **example** of a simple **PHP** file, with a **PHP** script that sends the text ...

[HTML - PHP Form Example](#)

www.tizag.com/phpT/examples/formex.php

Our **example** will show you a method using a single **.php** file, combining both ... We will be integrating more **PHP code** into our form as we continue on so be ...

[List All Sample Codes. PHP-GTK2 Cookbook](#)

www.kksou.com/php-gtk2/sample-codes/

Results 1 - 30 of 513 – List All **Sample Codes**. Collection of problems, solutions, ...

Sample Code	Title	Hits
Sample Code 1:	How to get started	31783
Sample Code 2:	How to change the size of GtkWidget	19894

let's check

*awwwwww ... *rageface**

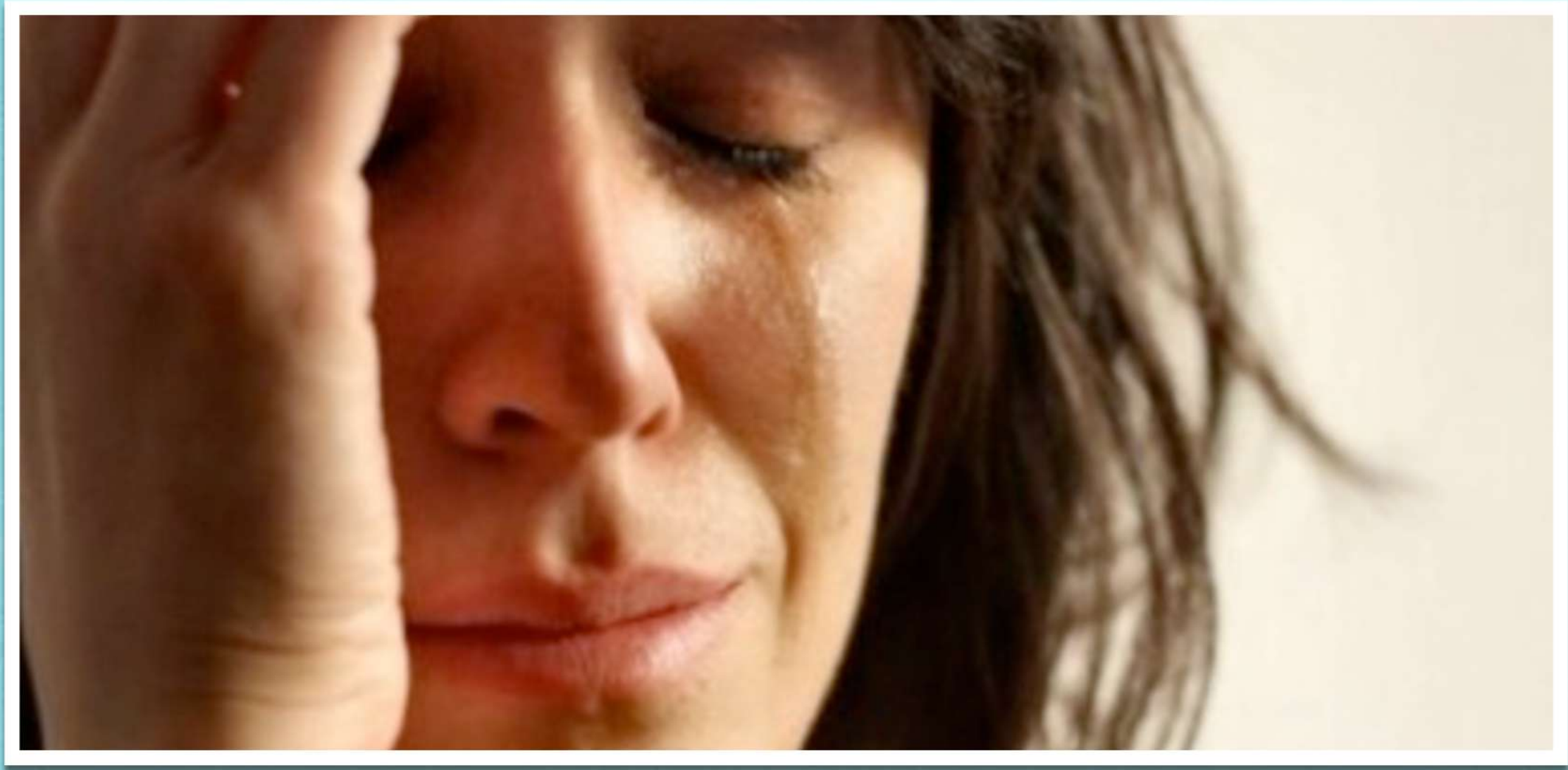

please STOP this!



please STOP this!

```
14 $link = mysql_connect($db_adr, $db_usr, $db_pwd);
15 if (!$link) {
16 die('keine Verbindung möglich: ' . mysql_error());
17 }
18 // DB Auswaehlen
19 $database = mysql_select_db ($db_name);
20 $data = mysql_query ("SELECT * FROM user");
21 echo "<h1>BENUTZERVERWALTUNG WPK PHP</h1>";
22 echo "<table border=1><tr><td>ID</td><td>Login</td>";
23 if($_SESSION[rights] == "admin")
24 {
25 echo "<td>Bearbeiten</td>";
26 }
27 echo "</tr>";
28 while ( $row = mysql_fetch_array ( $data, MYSQL_ASSOC ) )
29 {
30 echo "<tr><td>".$row['id']."</td><td>".$row['name']."</td>";
31 if($_SESSION[rights] == "admin")
```

yep! got it

This is how THEY know PHP!

could be me, trying to fixing php

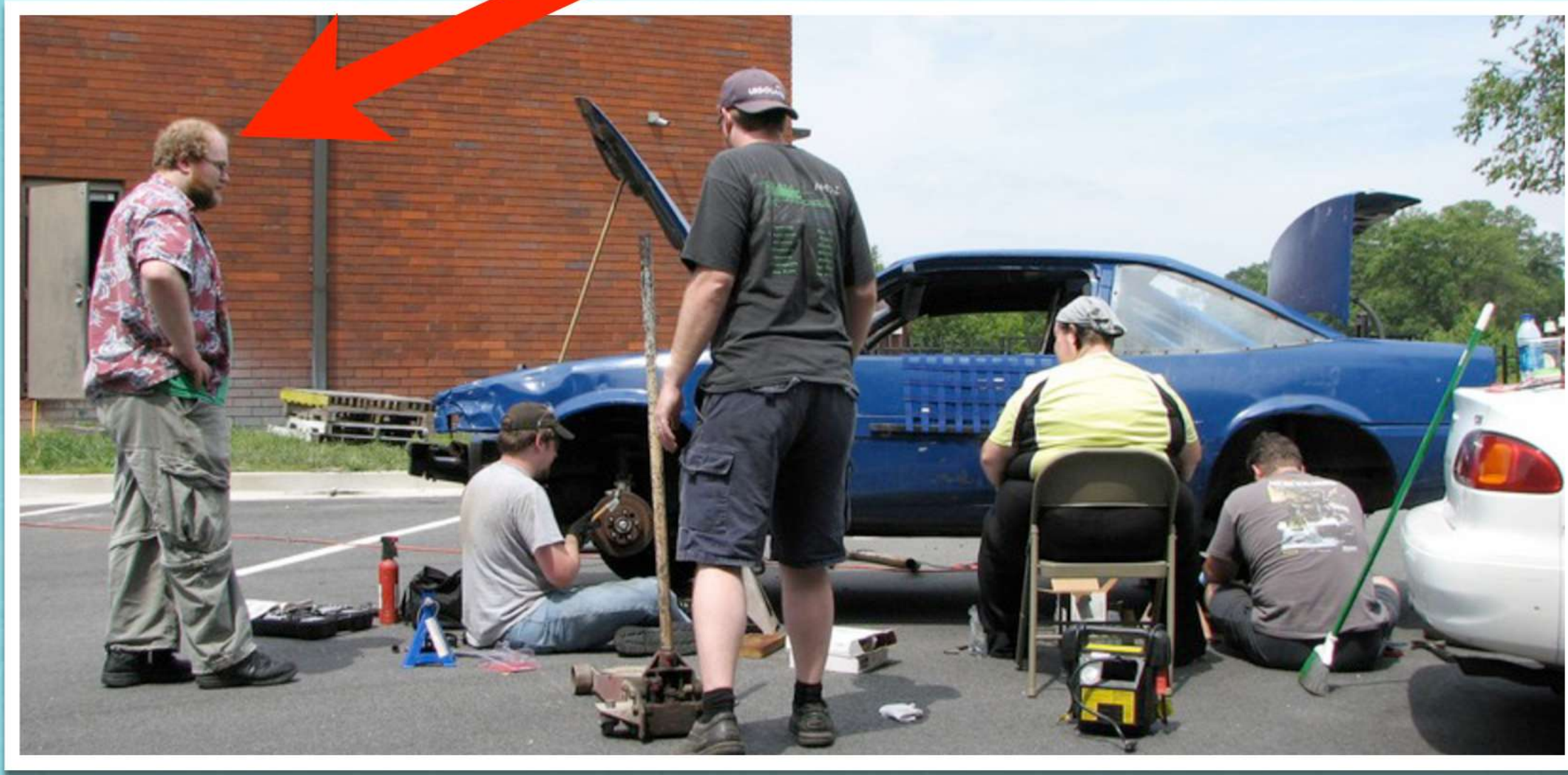

but... can't we just fix it?

**YES,
WE
CAN.**



http://farm3.static.flickr.com/2177/2238271809_3601c302b0.jpg

*indeed, we can
and it should not be that hard!*

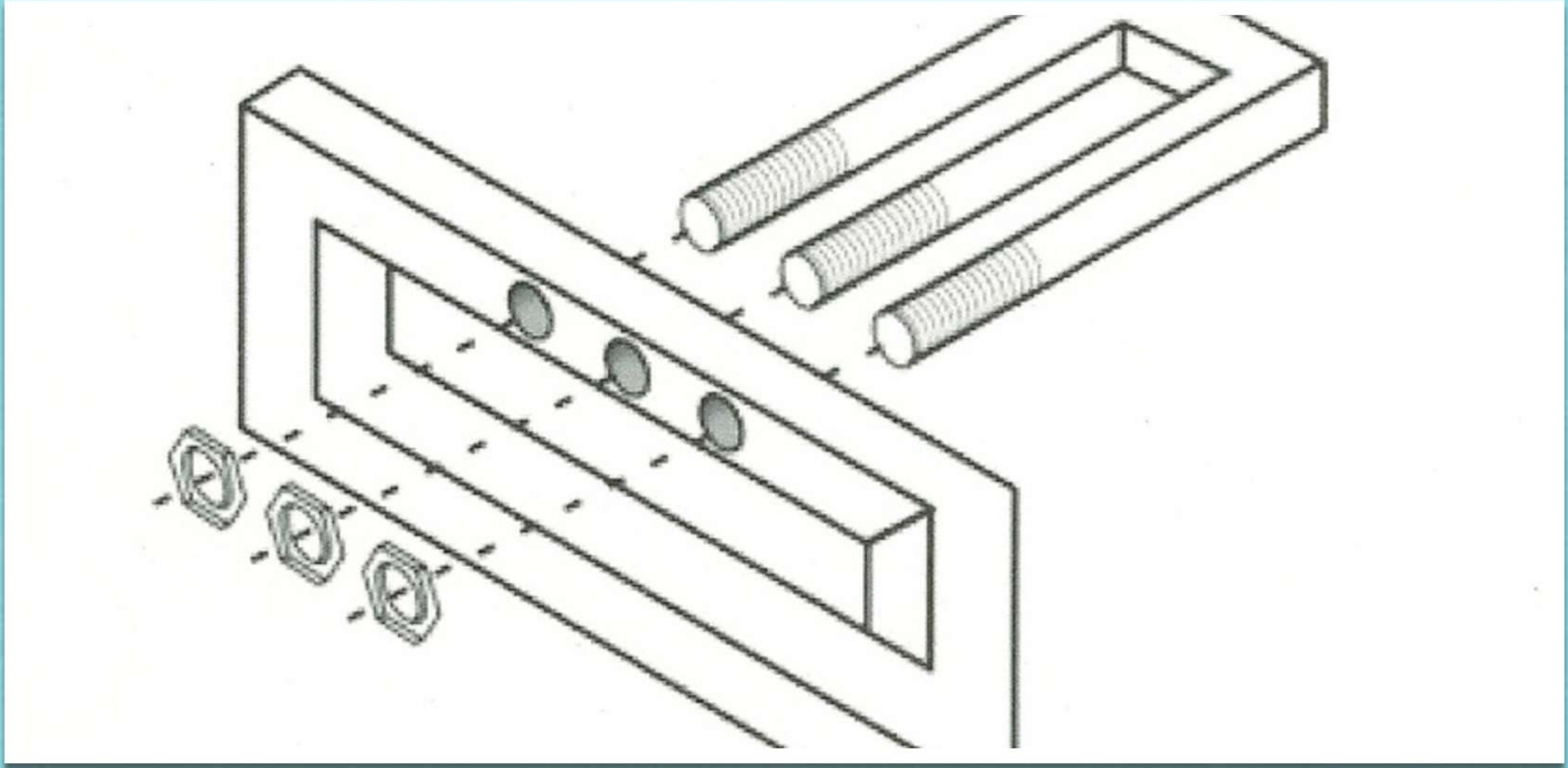

3 easy steps to fix php



1. participate

<http://munich2012.drupal.org/program/sessions/php-core-get-rid-bugs-and-contribute> | <https://wiki.php.net/rfc/voting> | <https://edit.php.net/> | <https://github.com/php/php-src> | <https://bugs.php.net/>

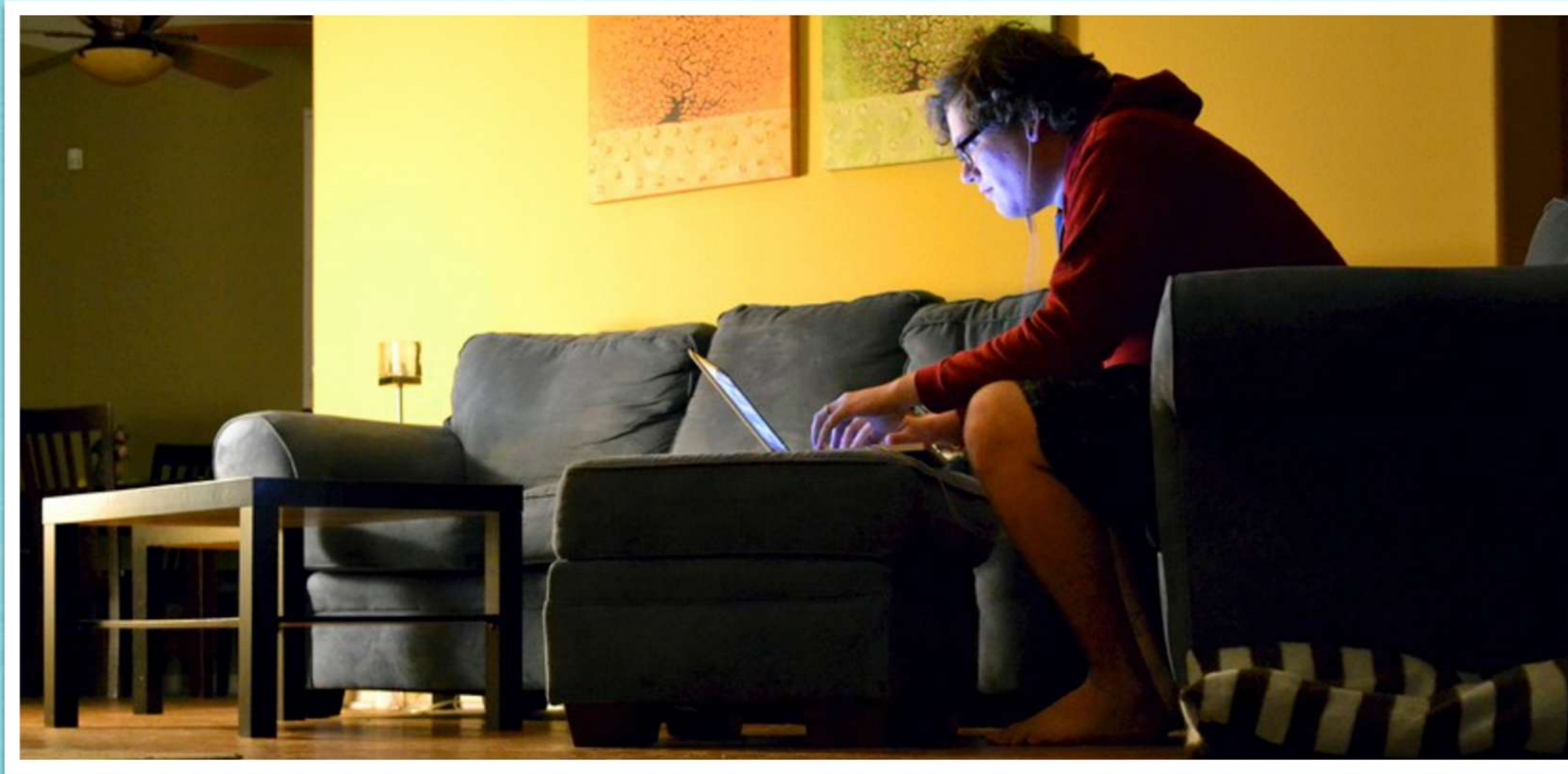

2. make it happen

Behat

Behat.phar , Mink.phar GitHub

A php framework for testing your business expectations.

Learn Behavior Driven Development with Behat



Register for Behat/BDD training



Read Quick Intro Guide



Read Behat2 Documentation Guides



Dependency Manager for PHP

[Getting Started](#)

[Download](#)

[Documentation](#)

[Browse Packages](#)

[Issues](#)

[GitHub](#)

Authors: [Nils Adermann](#), [Jordi Boggiano](#) and many [community contributions](#)

Logo: [WizardCat](#)



Web acceptance testing

One of the most important parts in the web is a browser. Browser is the window, through which web users interact with web applications and other users. Users are always talking with web applications through browsers.

So, in order to test, that our web application behaves correctly, we need a way to simulate this interaction between browser and web application in our tests. We need a Mink.

Mink is an open source acceptance test framework for web applications, written in PHP 5.3.

Installation

Mink is a php 5.3 library that you'll use inside your test suites or project. Before you begin, ensure that you have at least PHP 5.3.1 installed.

Method #1 (Composer)

The simplest way to install Mink with all its dependencies is through Composer:

CHAPTERS

1. Installation
 - Method #1 (Composer)
 - Method #2 (PHAR)
 - Method #3 (Git)
2. Understanding the Mink
3. Different Browsers - Drivers
 - GoutteDriver
 - SahiDriver
 - ZombieDriver
 - SeleniumDriver
 - Selenium2Driver
4. Control the Browser - Session
 - Basic Browser Interaction
 - Cookies and Headers

README.md

PHPPHP



A PHP VM implementation written in PHP.

This is a basic VM implemented in PHP using the [AST generating parser](#) developed by @nikic

To see what's supported so far, check out the [opcodes](#).

Right now, functions (definitions and calls) are supported, if statements (with basic boolean operations), if statements, as are variables and some basic variable operations...

To see the current state of the implementation versus the [Core Language Test Suite](#), check out the [test results file](#).

Installation



A php toolset to drive emergent design by specification.



phpspec2 repository



phpspec2 manual

PHP

The Right Way.

 Tweet 4,454

Fork me on GitHub

Last Updated: Tue Jan 22 19:06:07 -0500 2013

- Welcome
- Getting Started
- Use the Current Stable Version (5.4)
- Built-in Web Server
- Mac Setup
- Windows Setup
- Vagrant
- Code Style Guide
- Language Highlights
- Programming Paradigms

3. Installing PHPUnit

- PEAR
- Composer
- PHP Archive (PHAR)
- Optional packages
- Upgrading

4. Writing Tests for PHPUnit

- Test Dependencies
- Data Providers
- Testing Exceptions
- Testing PHP Errors
- Testing Output
- Assertions

- `assertArrayHasKey()`
- `assertClassHasAttribute()`
- `assertClassHasStaticAttr`
- `assertContains()`
- `assertContainsOnly()`
- `assertContainsOnlyInstar`
- `assertCount()`
- `assertEmpty()`
- `assertEqualXMLStructure()`
- `assertEquals()`
- `assertFalse()`
- `assertFileEquals()`
- `assertFileExists()`
- `assertGreaterThan()`
- `assertGreaterThanOrEqual`
- `assertInstanceOf()`
- `assertInternalType()`
- `assertJsonFileEqualsJsor`
- `assertJsonStringEqualsJs`
- `assertJsonStringEqualsJs`
- `assertLessThan()`
- `assertLessThanOrEqual()`

Chapter 1. Automating Tests

Even good programmers make mistakes. The difference between a good programmer and a bad programmer is that the good programmer uses tests to detect his mistakes as soon as possible. The sooner you test for a mistake the greater your chance of finding it and the less it will cost to find and fix. This explains why leaving testing until just before releasing software is so problematic. Most errors do not get caught at all, and the cost of fixing the ones you do catch is so high that you have to perform triage with the errors because you just cannot afford to fix them all.

Testing with PHPUnit is not a totally different activity from what you should already be doing. It is just a different way of doing it. The difference is between *testing*, that is, checking that your program behaves as expected, and *performing a battery of tests*, runnable code-fragments that automatically test the correctness of parts (units) of the software. These runnable code-fragments are called unit tests.

In this chapter we will go from simple `print`-based testing code to a fully automated test. Imagine that we have been asked to test PHP's built-in `array`. One bit of functionality to test is the function `count()`. For a newly created array we expect the `count()` function to return 0. After we add an element, `count()` should return 1. [Example 1.1](#) shows what we want to test.

Example 1.1: Testing array operations

```
<?php
$fixture = array();
// $fixture is expected to be empty.

$fixture[] = 'element';
// $fixture is expected to contain one element.
?>
```

README.md

Prophecy

build **passing**

Prophecy is a highly opinionated yet very powerful and flexible PHP object mocking framework. Though initially it was created to fulfill phpspec2 needs, it is flexible enough to be used inside any testing framework out there with minimal effort.

A simple example

```
<?php

class UserTest extends PHPUnit_Framework_TestCase
{
    private $prophet;

    public function testPasswordHashing()
    {
        $hasher = $this->prophet->prophesize('App\Security\Hasher');
        $user = new App\Entity\User($hasher->reveal());

        $hasher->generateHash($user, 'qwerty')->willReturn('hashed_pass');

        $user->setPassword('qwerty');

        $this->assertEquals('hashed_pass', $user->getPassword());
    }

    protected function setUp()
    {
        $this->prophet = new \Prophecy\Prophecy;
```



a SensioLabs product

DOWNLOAD NOW

- What is Symfony?
- Get started
- Documentation
- Community
- Services
- News
- About

Symfony is a PHP framework for web projects.

Speed up the creation and maintenance of your PHP web applications. Replace the repetitive coding tasks by power, control and pleasure.

SYMFONY IN 5 MINUTES

GET STARTED WITH SYMFONY

CASE STUDIES

Drupal, one of the world most popular Open-Source content management platform, uses the Symfony Components as of version 8. Read the case study >



a SensioLabsEvent PORTLAND 2013 MAY 20-24



WordPress is web software you can use to create a beautiful website or blog. We like to say that WordPress is both free and priceless at the same time.

The core software is built by hundreds of community volunteers, and when you're ready for more there are thousands of [plugins](#) and [themes](#) available to transform your site into almost [anything you can imagine](#). Over 60 million people have chosen WordPress to power the place on the web they call "home" — we'd love you to [join the family](#).

Ready to get started? [Download WordPress 3.5.1](#)

WordPress is also available in [Deutsch](#).

WordPress Swag



News From Our Blog

WordPress 3.5.1 Maintenance and Security Release

WordPress 3.5.1 is now available. Version 3.5.1 is the first maintenance release of 3.5, fixing 37 bugs. It is also a security release for all previous WordPress versions. For a full list of changes

It's Easy As...

- 1 Find a Web Host and get great hosting while supporting WordPress at the same time.
- 2 Download & Install WordPress with our famous 5-minute installation. Feel like a

WordPress Users



```

"name": "composer/composer",
"description": "Dependency Manager",
"keywords": ["package", "dependency", "autoload"],
"homepage": "http://getcomposer.org/",
"type": "library",
"license": "MIT",
"authors": [
  {
    "name": "Nils Adermann",
    "email": "naderman@naderman.de",
    "homepage": "http://www.naderman.de"
  },
  {
    "name": "Jordi Boggiano",
    "email": "j.boggiano@seld.be",
    "homepage": "http://seld.be"
  }
],
"support": {
  "irc": "irc://irc.freenode.org/composer",
  "issues": "https://github.com/composer/composer/issues"
},
"require": {
  "php": ">=5.3.2",
  "justinrainbow/json-schema": "1.1.*",
  "seld/jsonlint": "1.*",
  "symfony/console": "~2.1@dev",
  "symfony/finder": "~2.1",
  "symfony/process": "~2.1@dev"
},
"require-dev": {
  "phpunit/phpunit": "~3.7.10"
}

```



Packagist

The PHP package archivist.

Packagist is the main *Composer* repository. It aggregates all sorts of **PHP packages** or **submit your own**.

Search packages...

Getting Started

Define Your Dependencies

PHPPHP



A PHP VM implementation written in PHP.

This is a basic VM implemented in PHP using the [AST generator](#)

To see what's supported so far, check out the opcodes.

Right now, functions (definitions and calls) are supported, if statements and some basic variable operations...

To see the current state of the implementation versus the Co

In a Nutshell

Basically, the parser does nothing more than turn here as PHP has a ... uhm, let's just say "not nice"

For example, if you stick this code in the parser:

```
<?php  
echo 'Hi', 'World';  
hello\world('foo', 'bar' . 'baz');
```

```
args: array(  
  0: Arg(  
    value: Scalar_String(  
      value: foo  
    )  
    byRef: false  
  )  
  1: Arg(  
    value: Scalar_String(  
      value: barbaz  
    )  
    byRef: false  
  )  
)
```





Feature: Your first feature
In order to start using Behat
As a manager or developer
I need to try

Scenario: Successfully describing
Given there is something
When I do something
Then I should see something

```
/**  
 * @Given /^I am in a direct  
 */  
public function IAmInADirect  
{  
    throw new Pending();  
}
```

tweaked previous merge

 **fabpot** authored 2 hours ago

app	2 hours ago
src	14 days ago
web	5 months ago
.gitignore	2 months ago
.travis.yml	6 months ago
LICENSE	3 months ago
README.md	2 hours ago
UPGRADE-2.2.md	2 months ago
UPGRADE.md	3 months ago
composer.json	15 days ago
composer.lock	14 days ago



<i>Symfony Console Component</i>
symfony/yaml <i>Symfony Yaml Component</i>
symfony/finder <i>Symfony Finder Component</i>
symfony/routing <i>Symfony Routing Component</i>
symfony/translation <i>Symfony Translation Component</i>
symfony/process <i>Symfony Process Component</i>

Language Highlights

Programming Paradigms
Namespaces
Standard PHP Library
Command Line Interface
Xdebug

Dependency Management

Composer And Packagist
Pear

Coding Practices

The Basics
Date And Time
Design Patterns
Exceptions

Databases

Security

Web Application Security
Password Hashing
Data Filtering
Configuration Files
Register Globals
Error Reporting

Testing

Test Driven Development
Behavior Driven Development
Complementary Testing Tools

Servers And Deployment

Platform as a Service (PaaS)

Welcome

There's a lot of outdated info
for PHP best practices, accep

Translations

PHP: The Right Way is (or so

- [English](#)
- [Catalan](#)
- [Chinese](#)
- [Japanese](#)
- [Italian](#)
- [Polish](#)
- [Portuguese](#)
- Russian (Coming Soon)
- [Spanish](#)
- [Ukrainian](#)
- [Bulgarian](#)

Disclaimer

*There is no canonical wa
seasoned pros with fresh*

This is a living document

PHP

The Right Way.

Created and maintained by

Josh Lockhart

Project collaborators

Kris Jordan

Phil Sturgeon



3. spread the word



dark side

well, we should talk about that too



<http://www.flickr.com/photos/zanthia/6683299491/in/set-72157603955402874/>

the new world

a few free arguments just tailored for you

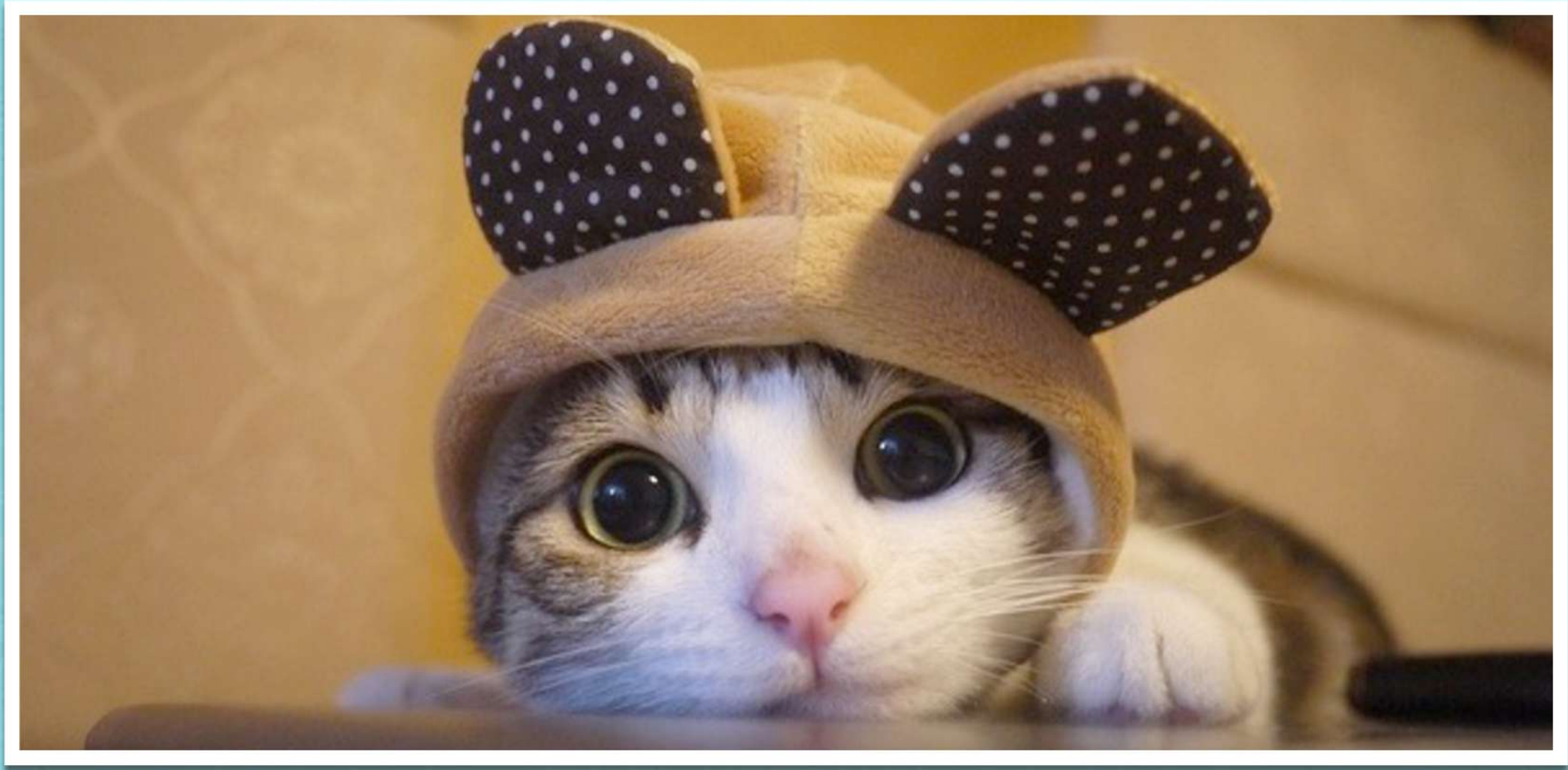

super easy for beginners

ohohh! cat content





open source



open source

**FUCK
YEAH!**

- 
1. [mxcl/homebrew](#): The missing package manager for OS X
 2. [rails/rails](#): Ruby on Rails
 3. [CyanogenMod/android_frameworks_base](#): Android base frameworks
 4. [CocoaPods/Specs](#): CocoaPods ([cocoapods.org](#)) specifications
 5. [symfony/symfony](#): The Symfony PHP framework
 6. [zendframework/zf2](#): Zend Framework
 7. [openstack/nova](#): OpenStack Compute (Nova)
 8. [saltstack/salt](#): Central system and configuration manager for infrastructure
 9. [TrinityCore/TrinityCore](#): TrinityCore Open Source MMO Framework
 10. [github/hubot-scripts](#): optional scripts for hubot, a customizable, kegerator-powered life embetterment robot

- 
1. [mxcl/homebrew](#): The missing package manager for OS X
 2. [rails/rails](#): Ruby on Rails
 3. [CyanogenMod/android_frameworks_base](#): Android base frameworks
 4. [CocoaPods/Specs](#): CocoaPods (cocoapods.org) specifications
 5. [symfony/symfony](#): The Symfony PHP framework
 6. [zendframework/zf2](#): Zend Framework
 7. [openstack/nova](#): OpenStack Compute (Nova)
 8. [saltstack/salt](#): Central system and configuration manager for infrastructure
 9. [TrinityCore/TrinityCore](#): TrinityCore Open Source MMO Framework
 10. [github/hubot-scripts](#): optional scripts for hubot, a customizable, kegerator-powered life embetterment robot

open source to the rescue



MORE
LESS

more than web

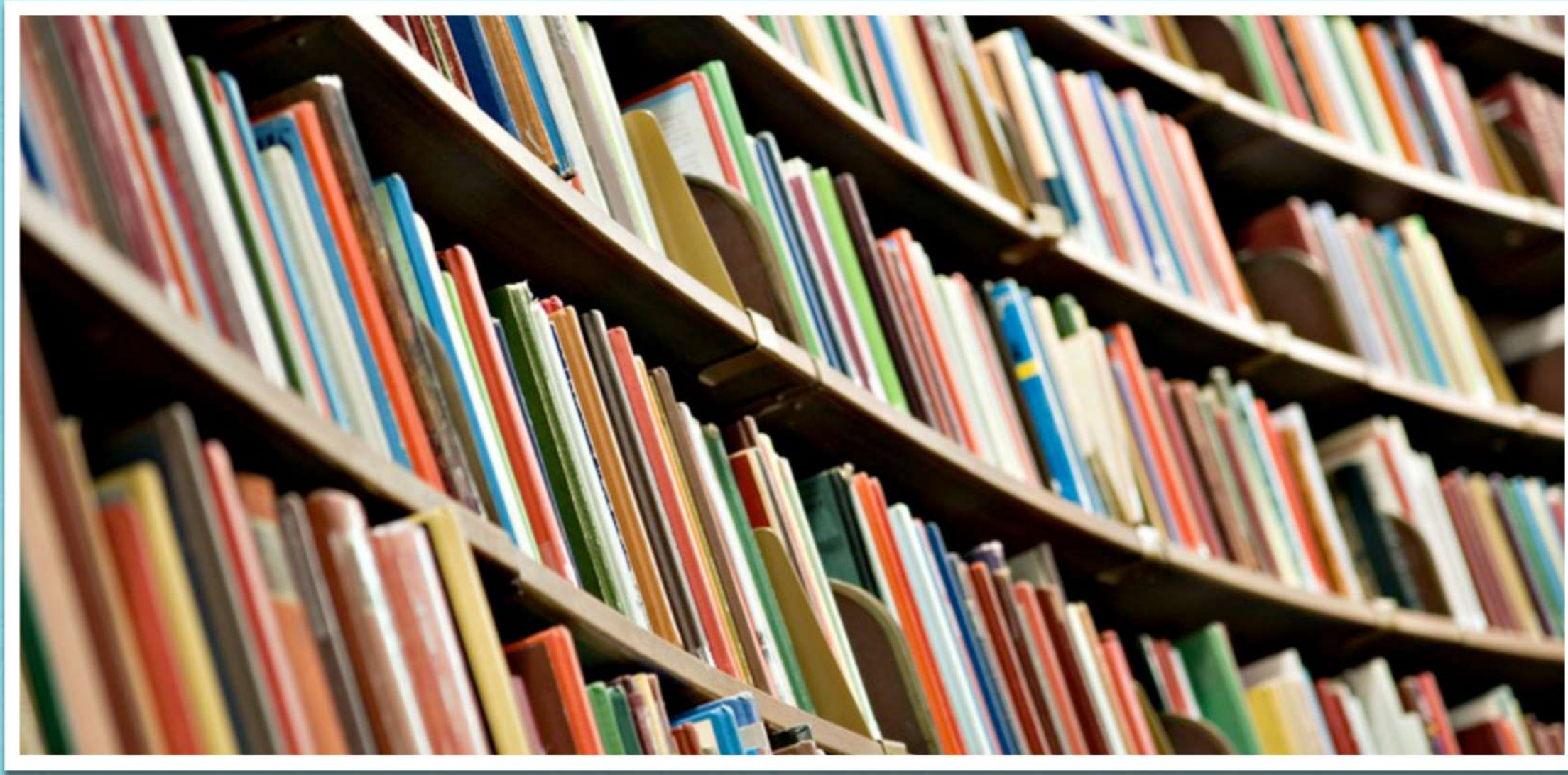

libraries

*SPL and tons of build-in functions plus
packagist*



let's get serious

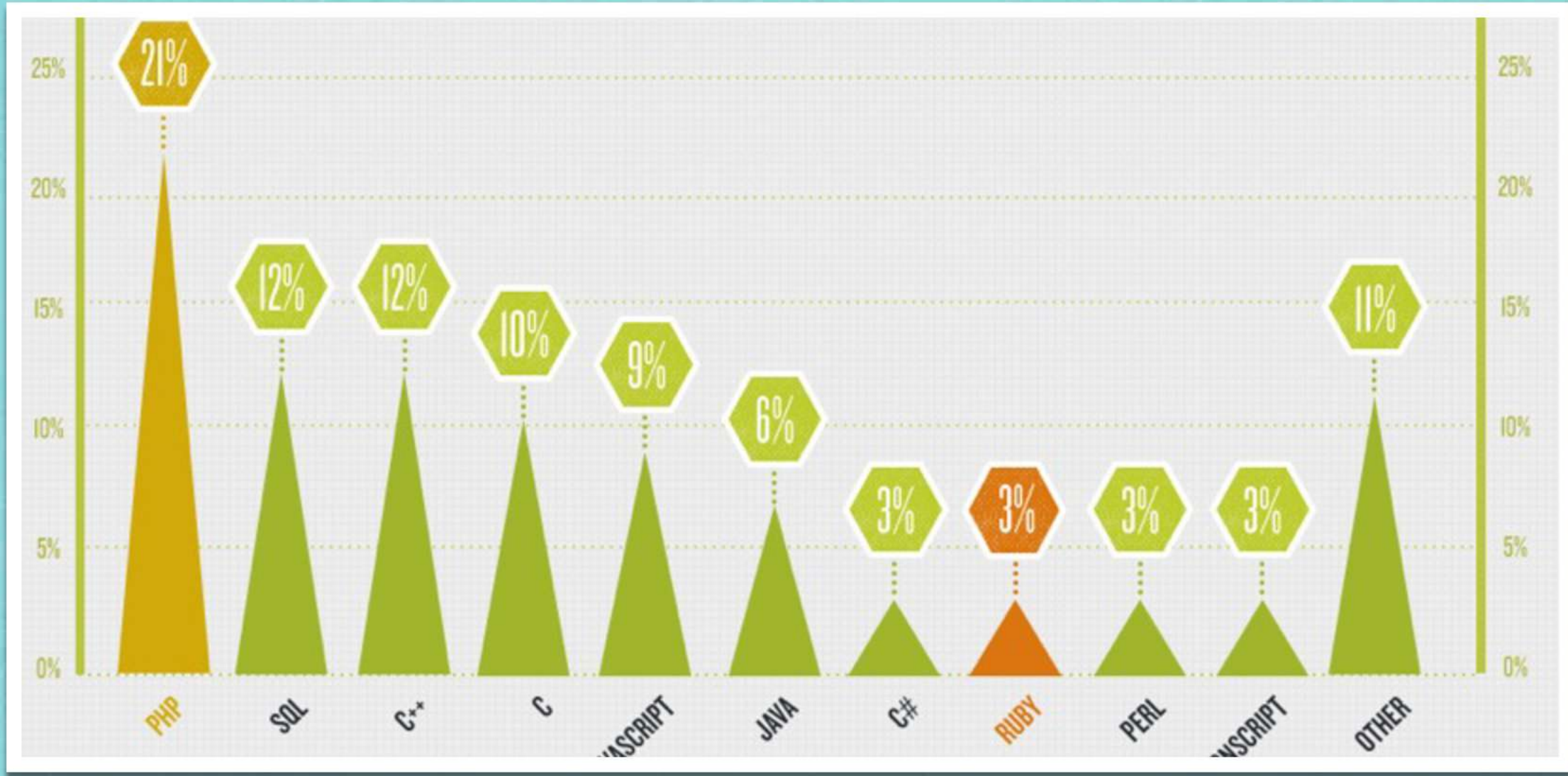



programmers wanted

*they
want
you,
really*

JOB POSTINGS ON MONSTER.COM

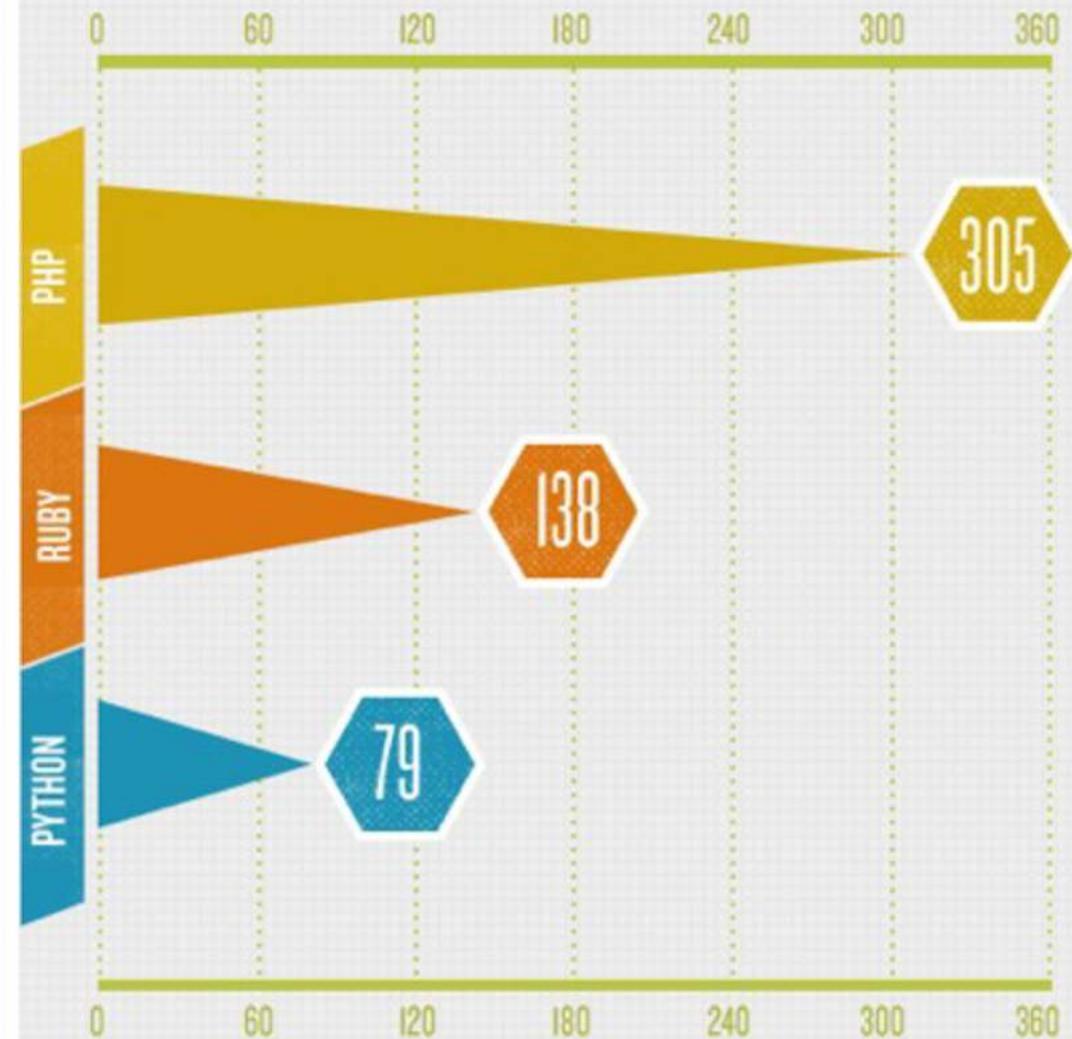
Below are the number of job postings as of December 12, 2011.



A photograph of Fabien Potencier, a man with short grey hair, wearing a blue and white striped shirt. He is shown in profile, looking towards the right, with his right hand raised in a gesture. A microphone is visible in front of him. The background is a plain, light-colored wall.

“PHP is probably not the best language out there, [...] but PHP is the best web platform...”

Fabien Potencier

“PHP is much better than you think”

A photograph of Fabien Potencier, a man with short grey hair, wearing a blue and white striped shirt. He is shown in profile, looking to the right, with his right hand raised in a gesture. A microphone is positioned in front of him. The background is a plain, light-colored wall.

“PHP is probably not the best language out there, [...] but PHP is the best web platform... ever.”

Fabien Potencier

“PHP is much better than you think”

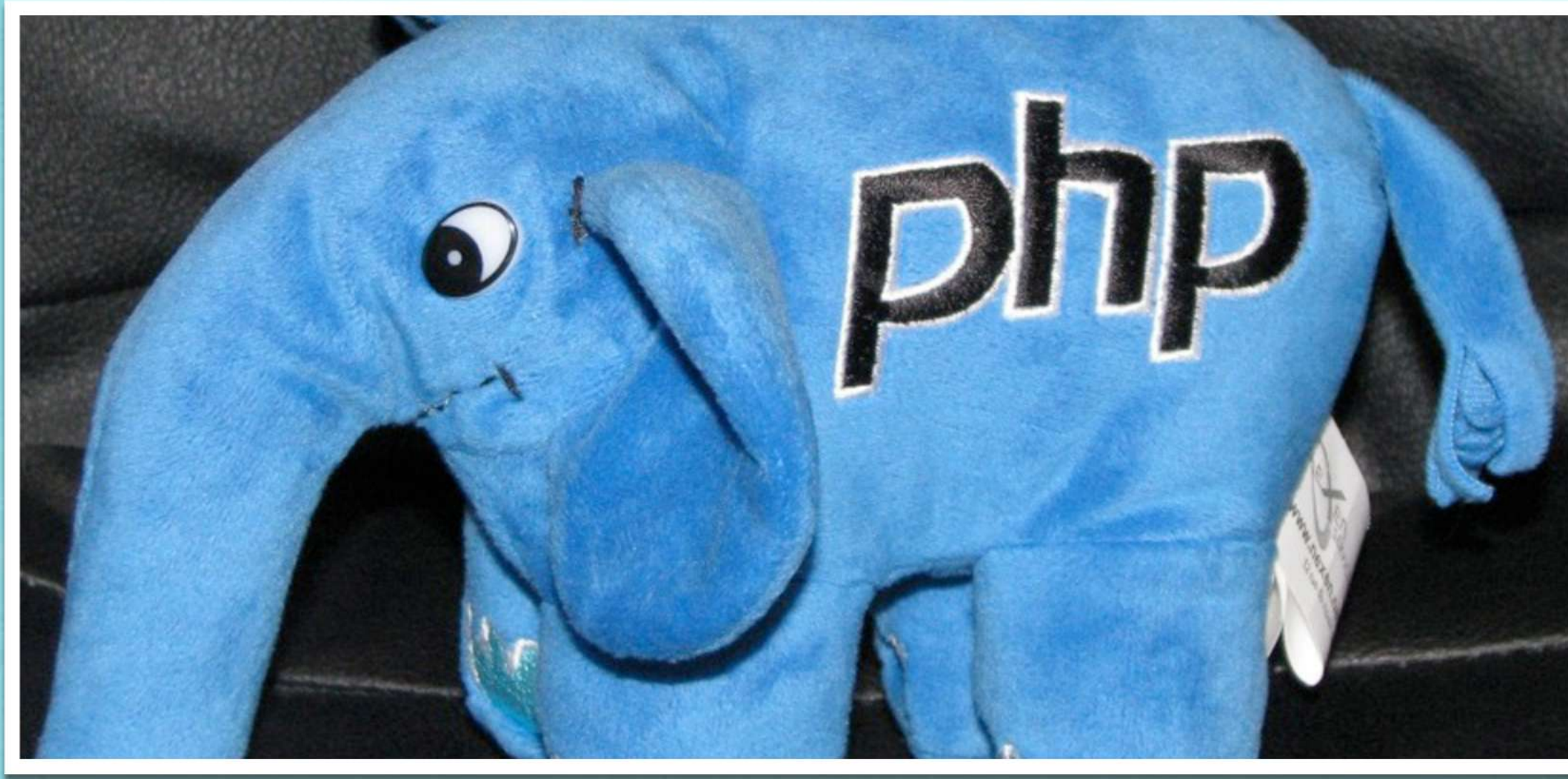

thank you!

*follow me on Twitter [@CodeStars](https://twitter.com/CodeStars) or
github.com/nesQuick*



questions?

*ask now or ping me later:
[@CodeStars](#) or Ole@jimdo.com*

sources

- ▶ <http://i.imgur.com/MQHBYB.jpg>
- ▶ <http://www.sxc.hu/photo/536650>
- ▶ http://farm3.static.flickr.com/2177/2238271809_3601c302bo.jpg
- ▶ <http://www.flickr.com/photos/tekkebln/6674676047/>
- ▶ <http://www.flickr.com/photos/ladytimeless/6872017034/>
- ▶ <http://www.flickr.com/photos/buhtterfly/3711487510/sizes/l/in/photostream/>
- ▶ <http://www.flickr.com/photos/dopey/6273168640/>
- ▶ <http://www.flickr.com/photos/stickwithjosh/5288115744/>
- ▶ <http://www.flickr.com/photos/hugo90/4455412652/>
- ▶ <http://www.flickr.com/photos/shebalso/7051794259/>
- ▶ <http://www.flickr.com/photos/christophedelso/6875754732/>
- ▶ <http://www.flickr.com/photos/ffx-florbelasfotographix/3593162929/>
- ▶ <http://www.flickr.com/photos/tom-poes/2525316618/>
- ▶ http://blog.claudiupersoiiu.ro/wp-content/uploads/2011/01/IMG_2959.jpg
- ▶ <http://images4.fanpop.com/image/photos/22600000/Remember-Don-t-Feed-the-Trolls-fanpop-22675484-412-341.jpg>
- ▶ <http://www.free-picture.net/albums/space/earth-night-day.jpg>



special thanks to all the
awesome people who supported
me so nice:

Elena <3
Nils
Fridel
Z

Sönke
Chris
JIMDO!